

Operating Instructions



Programmable Speed Monitor

rotas

CR • CRR • CRA • CRRA

The device is state of the art. It meets the legal requirements of the EC and is CE marked.



Devices which incorporate DC/DC transformers have additional approvals from appropriate authorities for marine applications.

© **2002**

All rights reserved. The contents of this booklet including data, statements and drawings for the application and operation of the device are protected by copyright and may not be reproduced in any form whatsoever without the prior written permission of the manufacturers.

The Purpose of this booklet

These Operating Instructions are essential for the safe application and operation of the Programmable Speed Monitor (hereafter referred to as the 'device').

It is essential that the safety notes and operational sequences contained in the manual are strictly observed, non-compliance with any of these could cause danger to personnel and damage to machinery.

Read the manual before using the device and if any part is not understood, contact the supplier for clarification before proceeding further.

Take care of the manual:

- Always have it available during the service life of the device.*
- If the device goes to a second user make sure that the manual goes with it.*
- Any supplementary instructions that may be issued later by the manufacturer, should be added to the manual.*

Specification changes due to product development may be made without further notice.

Technical specification details beyond the scope of this manual may be obtained by contacting the supplier or the manufacturer.

Contents:

1.	Safety	41
1.1	Limits of application	41
1.2	Assembling, electrical connections, programming and operation	41
1.3	If problems occur	42
1.4	Maintenance and warranty	42
1.5	Disposal and recycling	42
1.6	Explanation of symbols	43
2.	Description of the device and its functions	44
2.1	Technical features	44
2.2	Monitoring modes	46
2.3	Principle of measurement	48
3.	Identification	50
3.1	Package contents	50
3.2	Labeling	50
4.	Assembly and electrical connections	52
4.1	Assembling	52
4.2	Electrical connection	52
5.	Procedure at start-up	55
5.1	Monitoring Mode	55
5.2	Test Mode	56
5.3	Programming mode	57
6.	Programming	59
7.	Technical data	67
7.1	Operational Data	67
7.2	Operating Conditions	69
7.3	Mechanical Data	70

1. Safety

1.1 Limits of application

The safety notes and operational sequences described in this manual must be understood and observed by all personnel using the device.

The device is designed only for building into a control box. Assembly and operational criteria described in 'Technical data' (Section 7) must be observed in all respects.

The device is for measuring rpm and machine speed in applications that have standard industrial safety requirements, e.g. monitoring and controlling diesel engine speeds in power plants and ships. The programmable device processes pulse signals received from revolution sensors, moment of momentum or incremental measuring systems, digital revolution measuring instruments and proximity switches. It is also possible to process sinusoidal frequency signals using inductive induction sensors or analogue tacho-generators.

The manufacturers will not be responsible for accidents or damage caused by unqualified personnel or by failure to comply with the instructions in this manual.

1.2 Assembling, electrical connections, programming and operation

The assembly and electrical wiring of the device must be carried out by appropriately qualified personnel authorized by the factory management.

Operation and programming should be by personnel who have been trained to perform these activities and who are authorized by the factory management.

Information regarding the safe handling of the device can be found in sections 3 to 6 of this manual.

1.3 If problems occur

A watchdog is controlling all device functions. It notifies malfunctions through a flashing display. Additionally, the analogue output will be set to $> 22\text{mA}$. After a power supply reset, the watchdog will be reset too.

Any problem or failure of the device must be reported immediately to the foreman electrician and to the plant manager. The device should be isolated electrically and made safe from accidental operation.

If subsequent repairs involve dismantling the unit itself it should be returned to the manufacturer. Any unauthorized repair will invalidate the guarantee.

1.4 Maintenance and warranty

The device does not need servicing. Damage caused by rough handling or by attempts to open the casing will invalidate the guarantee and exclude the manufacturers from further liability.

1.5 Disposal and recycling

After decommissioning, the device should be disposed of as required by local regulations. Some electronic components whilst harmful to the environment do have a value, therefore recycling is advantageous.

1.6 Explanation of symbols

The following symbols are to warn or advise, they appear adjacent to the certain parts of the text to emphasize the relative importance of that item.



DANGER!

Potential for injury or death.



ATTENTION!

Potential for damage to the device or application.



INFORMATION!

Critical to the correct functioning of the device

2. Description of the device and its functions

2.1 Technical features

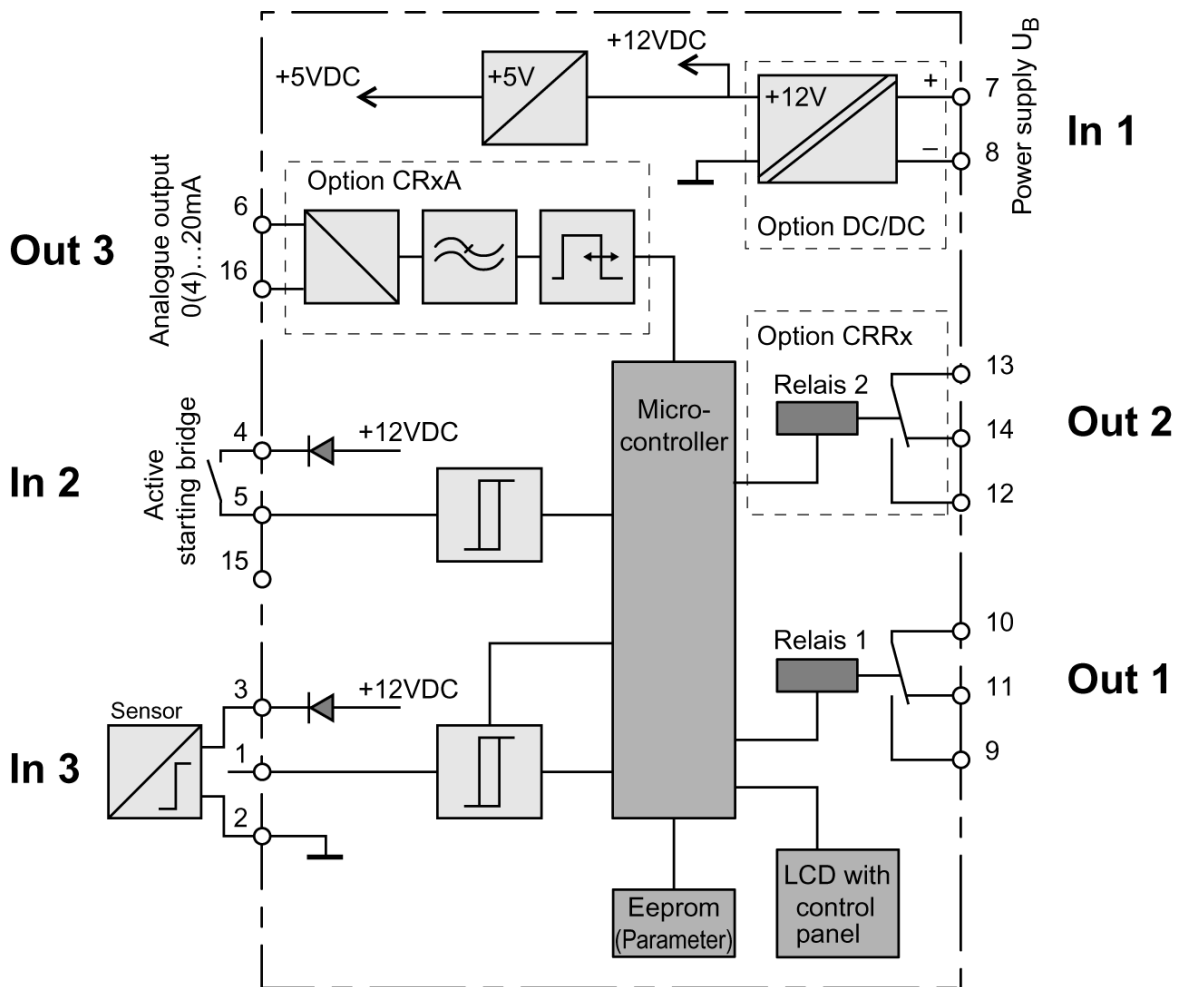

Figure 1 Basic circuit diagram

Power supply (Figure 1, In 1, ' Power supply U_B ')

Depending on the model, the device will require 18 to 36 V DC or, with a built-in DC/DC converter, 10 to 36 V DC.

Signal input (Figure 1, In 3)

The device disposes of a variable signal input: Three types of signals (PNP, NPN and Sine) and the Trigger level for the signal identification are programmable.

However the device is prepared to process signals of two-wire sensors as well as three-wire sensors.

Input (Figure 1, In 2, 'Active starting-bridge')

A pulse signal of $> 2.5V$ activates the Starting-bridge. This condition is maintained until the pulse signal drops below 1V and until the programmed Starting-bridge Time has elapsed.

If no signal is present on this input, start delay will not occur.

Outputs - Relay 1 and (optional) Relay 2 (Figure 1, Out 1& 2)

The output relays can be programmed for the following functions:

- Change-over function with selectable direction of contact i.e. normally open / normally closed.
- Speed monitoring and limiting for over-speed and under-speed (see section 2.2).
- Switch back value, starting-bridge and (Relay 1 only) switch-back time delay (see section 2.2).

Analogue output (Figure 1, Out 3)

The optional analogue output provides variable outputs of 0 to 20 mA or 4 to 20 mA. The output value is directly proportional to the measured variable so that variation of the current matches the variable being measured.

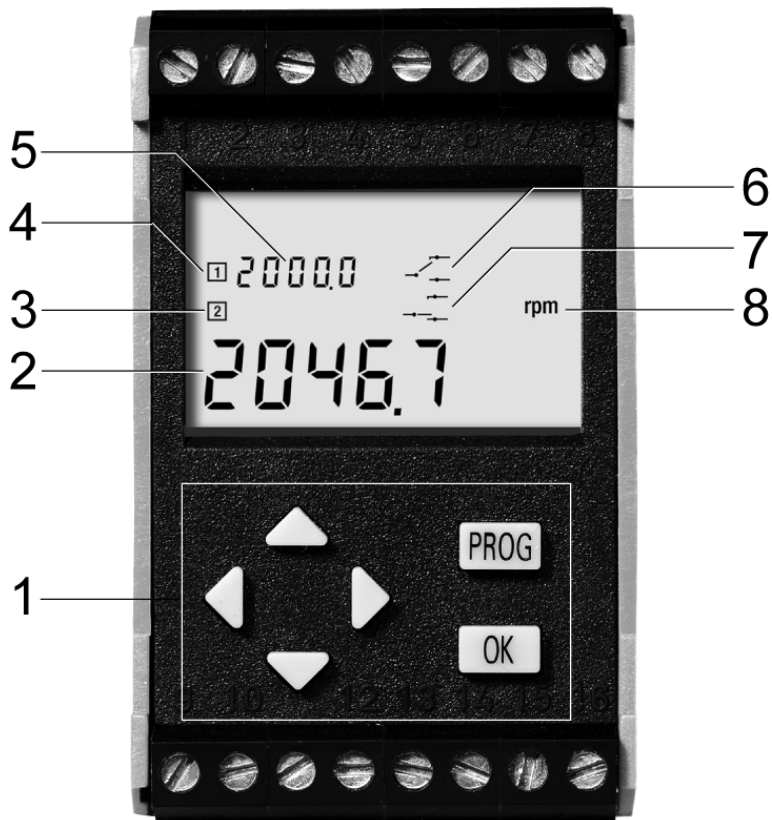

Figure 2 Front face of the device

The six key control panel (Figure 2, item 1)

The six keys allow simple programming of all functions.

The display (Figure 2, items 2 to 8)

During the monitoring mode the LCD display shows:

- Item 2. The current measured value.
- Item 3. Optional Relay 2.
- Item 4. Relay 1.
- Item 5. Set value of relay 1
(only displayed when set limits have been violated).
- Item 6. Switch position of relay 1.
- Item 7. Switch position of relay 2.
- Item 8. The unit of measurement.

2.2 Monitoring modes

The device can be programmed to perform the following functions:

Over-speed monitoring

The active relay switches to the alarm mode if the upper set speed limit is exceeded. When the speed drops back below the switch back value and when the switch back time delay has expired, the relay switches back to the normal phase.

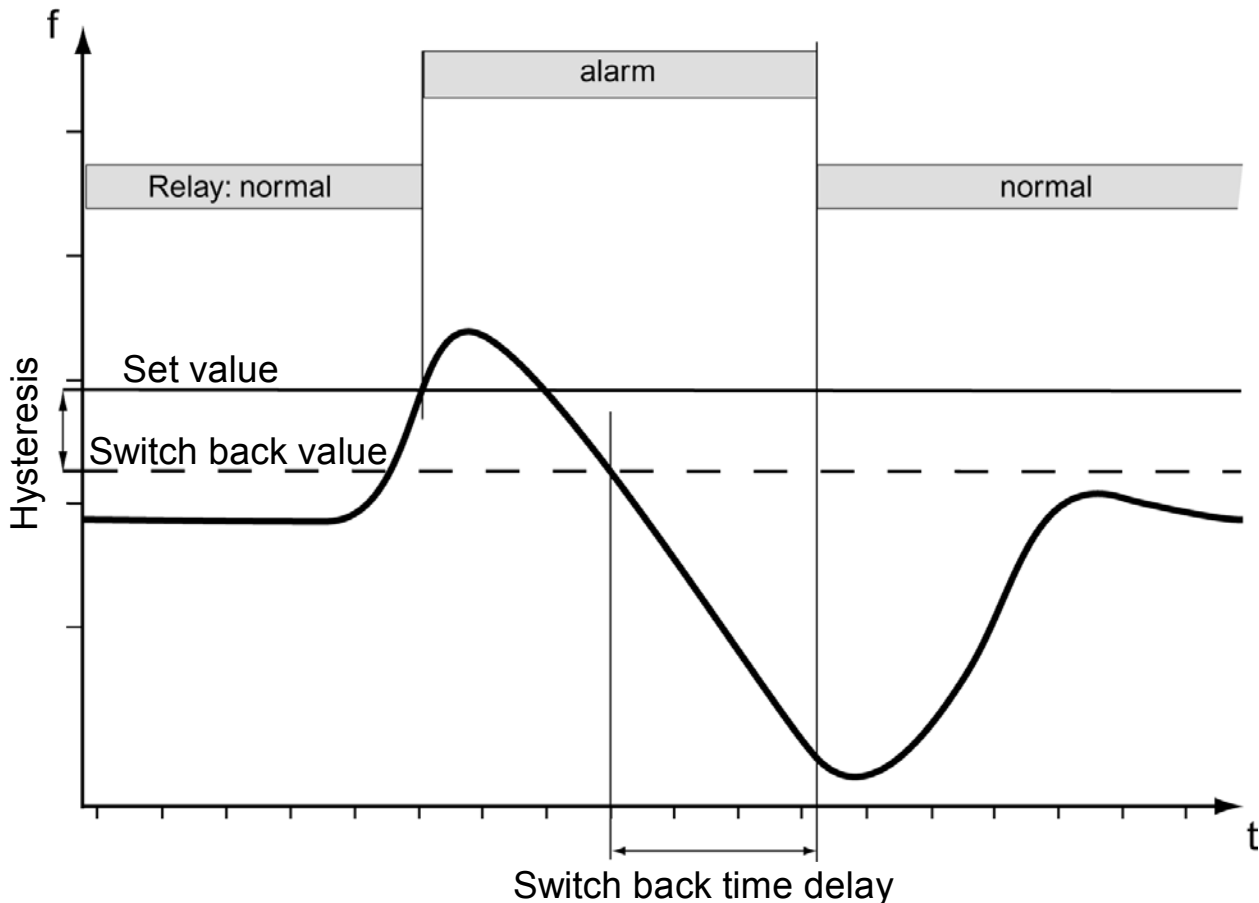

Figure 3 Over-speed monitoring and controlling

Under speed monitoring

After the starting-bridge time has elapsed, the active relay switches to the alarm mode if speed falls below the lower set limit, the voltage drops below the start voltage. When the speed increases to the set switch back value, the relay will switch to the normal phase. The starting-bridge time will only be effective if a signal is received at input 'Active starting-bridge' (Figure 1, In 2).

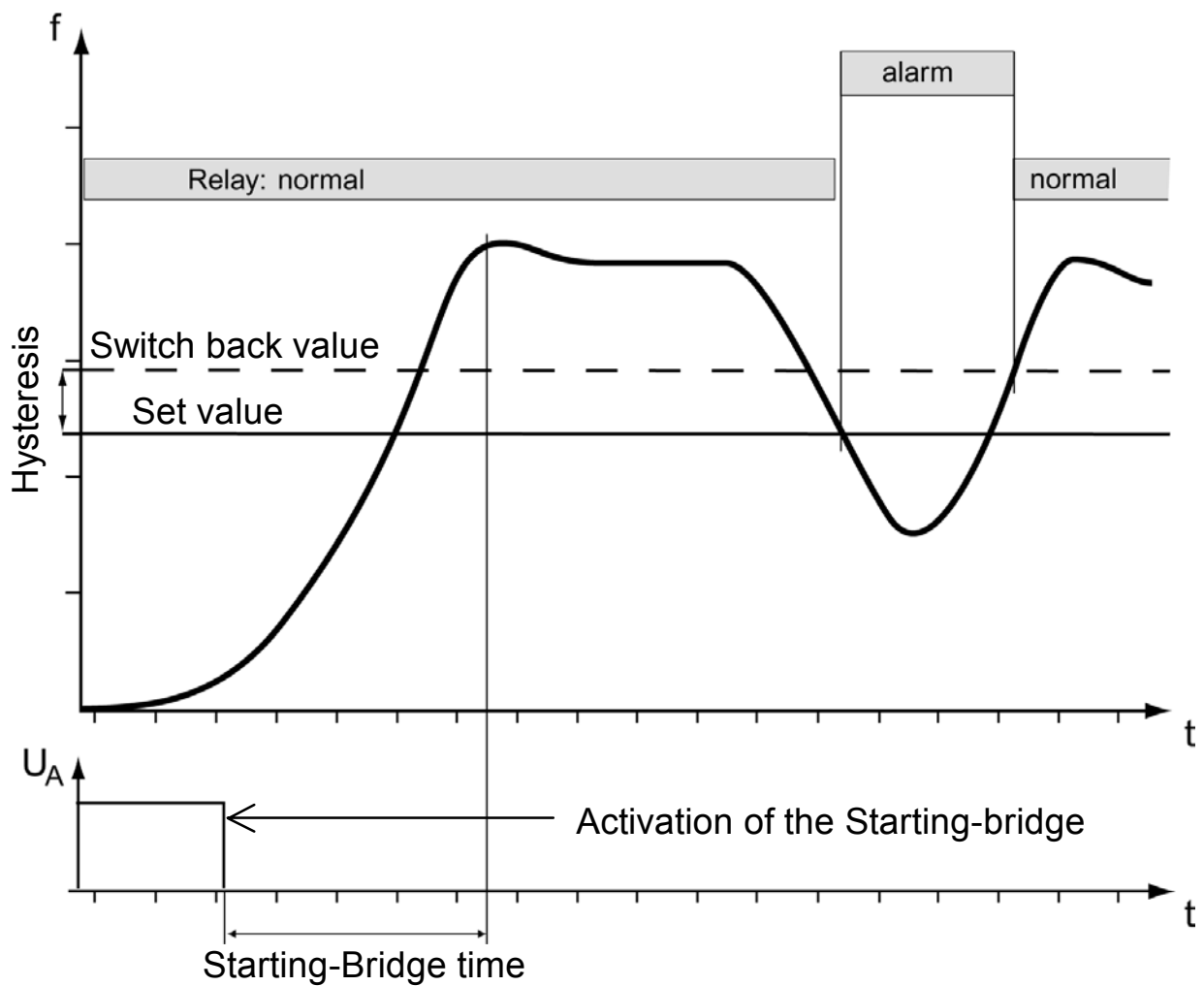

Figure 4 Under speed monitoring and controlling

Scope

The models CRR and CRRA are capable of monitoring simultaneously over-speed and under-speed.

2.3 Principle of measurement

The signal frequency at the signal input is modified by measuring a number of frequency periods to give an average figure. This is necessary to prevent fluctuations in switching response. The actual number of periods used for averaging will depend on programmed value of Relay 1 (Hz) and can be set according to Figure 5. Procedure to establish signal frequency is discussed in 'Special Functions' Section 6.

A typical example would be to measure the pulse period variations over a complete revolution of the machine and then take the average.

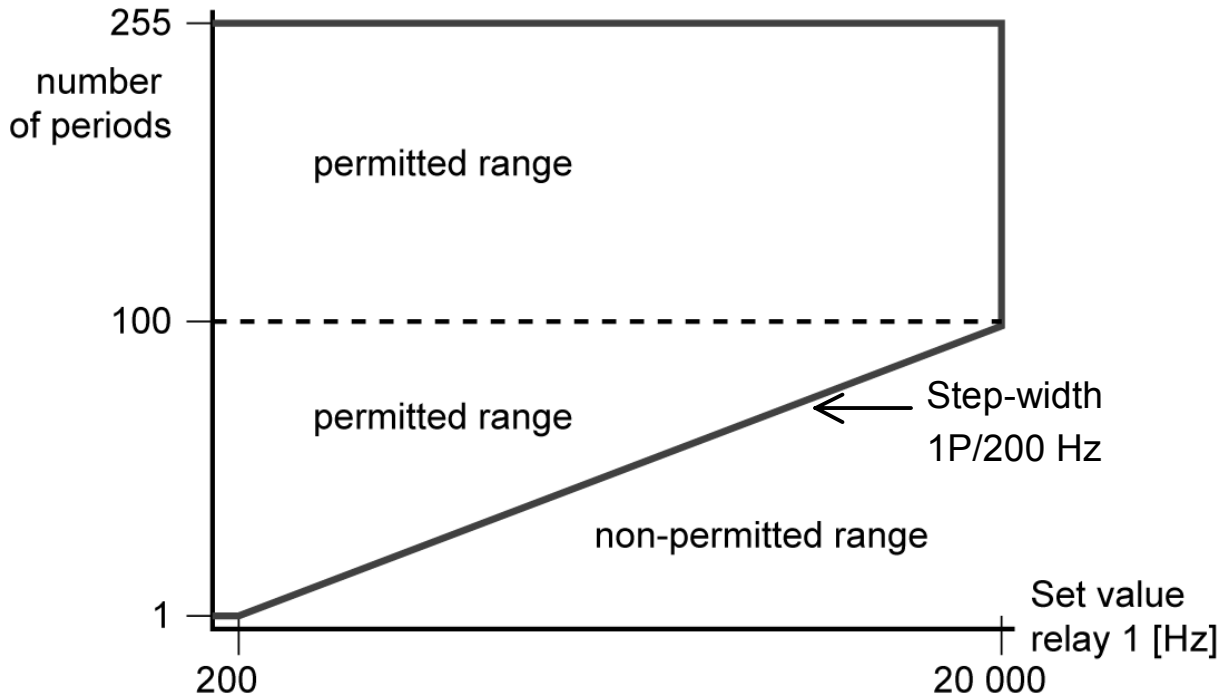

Figure 5 Acceptable number of periods allowed for averaging

3. Identification

3.1 Package contents

When delivered the package will contain:

- A Speed Monitor to specification ordered
- This Operating Instruction booklet

3.2 Labeling

There are two labels on the exterior of the device that show the following data:

- Model Code
- Part Number
- Customers ID number (If given)*
- The programmable parameters of the device
- Any factory pre-programming of these parameters*
- Country of origin
- Mark of Conformity
- The pin configuration

* Only where the device has been customized

3.3 Variants

Model	Output	Analogue output	Power supply	Part number
CR	1 Relay	without	18...36 V DC	5810.100
CRR	2 Relays	without	18...36 V DC	5810.200
CRA	1 Relay	with	18...36 V DC	5820.100
CRRA	2 Relays	with	18...36 V DC	5820.200
CR	1 Relay	without	10...36 V DC/DC	5813.100
CRR	2 Relays	without	10...36 V DC/DC	5813.200
CRA	1 Relay	with	10...36 V DC/DC	5823.100
CRRA	2 Relays	with	10...36 V DC/DC	5823.200

Table 1 Model options and power requirements

A Part Number with the suffix letter P denotes that the device has been customized by the factory before delivery.

4. Assembly and electrical connections



ATTENTION!

Possible impairment of the device function!

To ensure correct functioning, the device should only be operated within the conditions described in Section 7, 'Technical Data'.

The switching delay of the relay outputs subsequent to detection of under or over speed, is governed by the number of periods required to determine an average value. For correct functioning this must be set up as described on page 65.

4.1 Assembling

The device is designed for attachment to a 35 mm mounting rail.

A drawing showing key dimensions is contained in Section 7.3.

4.2 Electrical connection



ATTENTION!

Before a power supply is connected, the model Type Code should be ascertained from the label then identified in Section 3.1, Table 1, columns 1 & 4 to establish the correct power requirement.



DANGER!

Danger voltage!

Before any wiring connections are made to the relays of the device, the relays must be in power down positions and the power supply switched off.

The relay contacts must both operate at the same voltage. Examples:

NOT allowed: *Relay 1 with mains voltage (230 V) and relay 2 with low voltage (24 V)*

Allowed: Relay 1 and relay 2 with mains voltage (230 V)

Allowed: Relay 1 and relay 2 with low voltage (< 42 V)



INFORMATION!

The device does not require earthing.

Terminal numbering is shown on one of the two exterior labels.

The electrical connections should be made in accordance with Table 2 using Figure 6 to identify the terminal numbers.



Figure 6 Numbering of the terminal screws.

5. Procedure at start-up

The device has three modes:

- Monitoring mode. See Section 5.1.
- Test mode. See Section 5.2.
- Programming mode. See Section 5.3.



ATTENTION!

Before using the device, check that its specification is correct for the application and that, if required, it has been correctly programmed. See Section 5.3 and 6).



INFORMATION!

Customized devices that can be recognized by the suffix letter P to the part number have the programming factory set. Settings are shown on one of the two data labels attached to the housing. After checking that these settings are correct, the monitoring operation can be started.

Test Mode and Programming Mode are both accessed through the Monitoring Mode.

5.1 Monitoring Mode



INFORMATION!

When the device is monitoring, the decimal point of the display will flash.

Switch on the power supply.

All segments of the LCD display will light up for a short period to allow a check for faulty segments. This display-test will be prolonged as long as the 'OK'-key is pressed. Thereafter the device will automatically start monitoring.

5.2 Test Mode



ATTENTION!

Potential for inadvertent switching!

When the Test mode is activated, the relay will switch if the system is currently running at a level outside the parameters for which the device is programmed.

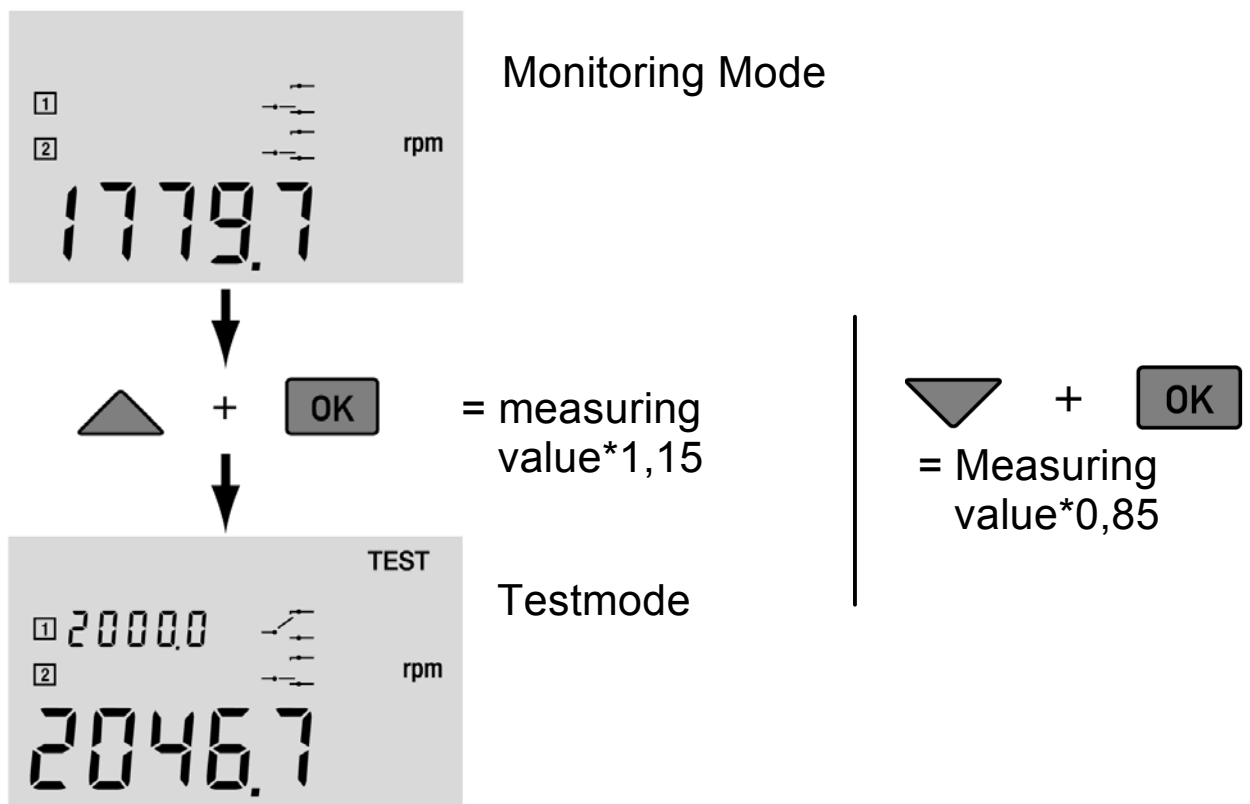

Figure 7 Test Mode keys

Activating the Test mode

With the device running in the Monitoring Mode, press and hold down the OK key and the UP arrow key (the DOWN arrow key) simultaneously.

During this procedure, switching will be tested at set values plus 15% and minus 15% (see Figure 7).

Releasing the keys will terminate the test sequences.

5.3 Programming mode

Assuming that a customer has not specified programming at the factory, the device will be delivered with the standard default settings as shown in Table 3.

No.	Parameter	Default values	
Access			
3,4	User code	00000	
Signal processing			
6	Unit*	rpm	
7	No. of pulses per unit*	60	
8	Input variable*	pnp	
20	No. of periods for the average**	15	
21	Trigger level signal input**	6,0 [V]	
Behavior of the relays		Relay 1	Relay 2 (Optional)
10	Limiting value*	1000,0	3,0
11	Monitoring direction*	↑	↑
12	Direction of contacts for the state of alarm*	nc	nc
13	Switch back value*	850,0	1,0
18	Switch back time delay**	00.0 [sec]	–
19	Starting-bridge time**	00.0 [sec]	=
Analogue output (optional)			
14	Offset*	4 [mA]	
15	Scaling factor*	1000 = 20 mA	
“No.” pretends the belonging-programming step. * Standard functions ** special functions			

Table 3 Parameters of the device and default values

The programming mode is started by pressing the 'PROG' key.

Programming stages

There are three programme stages, the programming steps referred to below are described In Section 6:

The first stage establishes the User Code (see Table 3); it covers steps 1 to 5.

The second stage programmes the Standard Functions; it covers steps 1 to 3 and 6 to 16.

The third stage programmes Special Functions; it continues from second stage after step 15 and is started by pressing the left and right arrow keys simultaneously (Programme step 17). Thus special programming includes steps 1 to 3, steps 6 to 15 and steps 17 to 22.

During programming, progress is indicated by a flashing cursor at the current entry. If input is delayed by more than approximately five minutes, the sequence will exit the programming mode, the settings will revert to the previous values and the device will automatically resume monitoring.

Each entry must be confirmed by pressing the OK key and all steps must be completed to achieve correct programming.

Pressing the PROG key at any point in the sequence will exit the programming mode, the settings will revert to the previous settings and the device will automatically resume monitoring.

6. Programming



INFORMATION!

When the Programme Mode is entered and pre-set parameters are changed, these settings should be noted and retained on file, for future reference.

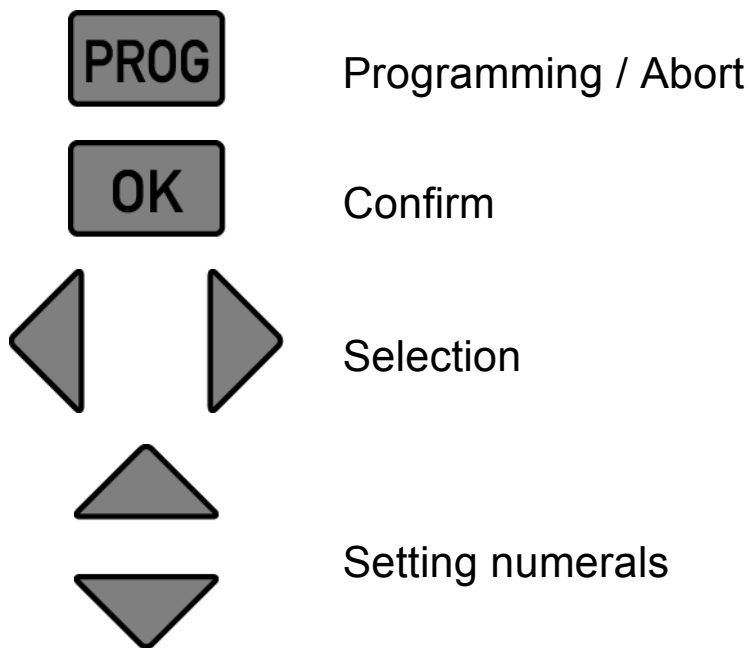

Figure 8 The programming keyboard



INFORMATION!

Refer to the fold-out diagram of the of the programming path for assistance during programming.

1

Start the programming operation.

2

Enter user code or PROG.



INFORMATION!

At the first time of programming for standard devices, (i.e. not customized by the factory) the code will read '00000'; this may be left, in which case ignore steps 3 & 4. The mode is accessible until another code is entered during steps 3 or 4 at which time the display changes to '- - - - -' therefore the new code must be noted.

If the device has been factory pre-programmed the code is '11111' but the display reads '- - - - -'.

- 3** For an existing code, enter the code.
- 4** Enter a new code overwriting the existing one.
- 5** Terminate the code programming.
- 6** Select a unit of measure.
Selectable units of measure are: rpm, Hz, pulses/min, pulses/h, m/sec, m/min, m/h, km/h, in/sec, in/min, in/h, mi/h, ft/sec, ft/min, ft/h.
- 7** Select number of pulses per unit.



ATTENTION!

The number of pulses per unit governs the maximum limiting value when monitoring speed. If the existing number is changed, the existing limiting values must be checked during steps 10 & 10'.

The number of pulses per unit must always be entered except when the selected unit is Hz. The maximum number of pulses per unit is 10000 and the minimum is one.

8

Set the input variable.

This setting matches the type of input sensor to the internal circuitry of the device. Setting options are:

pnp ... 10 k ohm Pull Down resistance at 0 V.

npn ... 10 k ohm Pull Up resistance at +12 V.

sin ... no resistance connected.



INFORMATION!

The trigger levels will set automatically to 6.0 V for 'pnp' & 'npn' and to 2.5 V for 'sin', regardless of the selected input variable.

The trigger level can be adjusted to a different value by using the programme path 'Special functions' but the trigger level will automatically revert to the default value if the programme path 'Standard function' is reset. Therefore if a non-standard trigger level is necessary it must be reset at every programming.

9

Set the decimal point for the measuring range.

The position of the decimal point defines the resolution of the measuring range.

10

Set the limiting value of Relay 1.



ATTENTION!

Potential for system malfunction!

The limiting value must be lower than the maximum value governed by the number of pulses per unit (see step 7). The software will not recognize an incorrect input.

Equation 1:

$$M = \frac{20000\text{Hz}}{Q} * \frac{Z}{ZE}$$

M: Maximum value; Q: No. of pulses / unit of length; ZE: Unit of time; Z: Unit of time in sec

Example: no. of pulses 1000, Unit of length is m und unit of time is min:

$$M = \frac{20000\text{Hz}}{\frac{1000}{m}} * \frac{60\text{sec}}{\text{min}} = 600 \frac{m}{\text{min}}$$



INFORMATION!

The limiting value of Relay 1 should be higher than Relay 2:

Relay 1 is used to derive the parameters of the device when considering the number of pulses required to establish the average value.

Special function 'Switch back delay' is only programmable on Relay 1.

This ist the point at which the alarm phase is entered.

11

Set the monitoring direction of Relay 1.

Monitoring over-speed is indicated by an up arrow (↑).

Monitoring under-speed is indicated by a down arrow (↓).

12

Set the contact position for relay 1.

This defines the relay contact position during the **alarm state**. (see Figure 9)

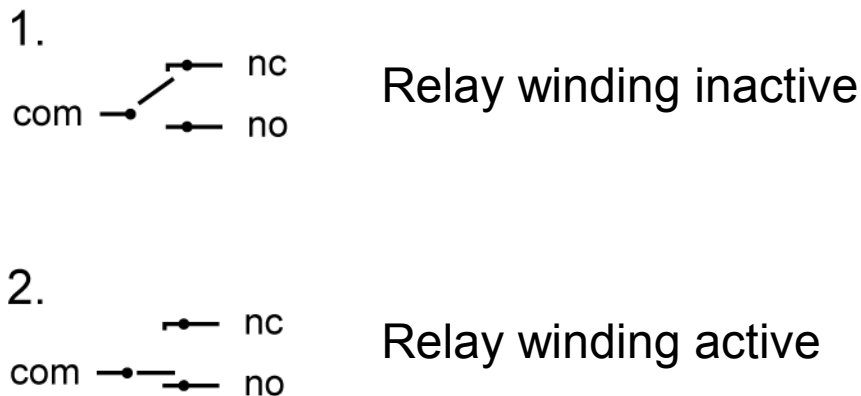

Figure 9 Relay contact position in the alarm state.

13

Set the switch back value of relay 1.

The switch back value is the threshold value for switching back to normal running. The difference between the limiting value and the switch back value is the 'Hysteresis' (see Figure 3 and Figure 4). The hysteresis is set at a level that will prevent 'fluttering' of the relays.

Setting the optional Relay 2

Steps 10' to 13' are the same as 10 to 13 carried out for Relay 1.

- 10' Set the relay value for Relay 2.
- 11' Set the monitoring direction of Relay 2.
- 12' Set the contact position for relay 2.
- 13' Set the switch back value of relay 2.



INFORMATION!

The function 'Switch back delay time' is not available for Relay 2.

- 14 Set the offset of the optional analogue output.
The offset has a default of 0 mA and must be set at this or at the alternative 4mA.
- 15 Set the scaling of the optional analogue output.
Scaling fixes the ratio of the measured output to the analogue output of 20 mA so that the set figure equates to 20 mA.
- 16 Memorize the programmed data.
This will be memorized as 'Standard functions'.

17 Start the programme path 'Special functions' pressing the left and right arrows simultaneously (instead of step 16).

18 Set the Switch Back delay time.
This function is only used for over speed monitoring in combination with Relay 1. Setting range is 0.00 to 99.9 seconds.

19 Set the Starting-bridge time.
This function is only used for under speed monitoring but can be used on both relays.
Setting range is 0.00 to 99.9 seconds.

20 Set the number of periods required to average the measured value within the indicated minimum and maximum values (see section 2.3).



ATTENTION!

Potential for damage to the monitored system.

The switch back delay of the relay outputs is dependent on the programmed number of periods required to average the measured value and is calculated by the following equation:

Equation 2:

$$t_s = 20ms + (z + 1) \times T$$

t_s: switch delay; z: no. of periods; T: duration of the period at the switch frequency

21 Set the trigger level of the signal input:
Based on the programmed type of signal done in the programming step "Set type of signal input"

the software of the device proposes a value. On principle the trigger level should be selected as high as possible to provide high disturbance resistance.

Proposal of the device:

Signal type	Trigger on:	
	high	low
NPN, PNP	6,0 V	2,5 V
Sinus	2,5 V	1,0 V
	0,7 V	0,2 V

The device always indicates the higher trigger level.



INFORMATION!

The trigger levels automatically revert to default setting if the Standard Functions data is reset.

22

Automatic data storage.

The parameters set in Standard Functions and Special Functions are now memorized automatically.



7. Technical data

7.1 Operational Data

Speed monitoring	
Range	0,01Hz...20 000 Hz
Accuracy	< +/- 0,03% of final value +/- 1 Digit
Temperature coefficient	< +/- 0,01% of final value
Switch delay	< 20 ms + measuring time (see page 65)
Power supply UB	
Voltage	18...36 V DC
... with DC/DC-converter	10...36 V DC (optional)
Current consumption	< 160 mA at 24 V DC
... with DC/DC-converter	< 120 mA at 24 V DC
Signal input	
Type	NPN, PNP or Sinus signal
Internal resistance [R _{in}]	NPN/PNP: 10 kΩ
	Sinus: 100 kΩ
Trigger level	NPN/PNP: U _{high} > 6,0 V; U _{low} < 2,5 V
	Sinus: U _{high} > 2,5 V; U _{low} < 1,0 V
	Others: U _{high} > 0,7 V; U _{low} < 0,2 V
Frequency range	0...20 000 Hz
Max. input voltage	36 V DC
Min. pulse width	20 μs

Min. interpulse period	20 μ s
„Active starting-bridge“ input	
Trigger level	U_{high} 2,5 V...36 V; U_{low} < 1,0 V
Relay outputs	
Number	1 or 2 (optional)
Type	Change-over contacts
Switching voltage (!!! Safety note sect. 4.2)	AC: \leq 250 V
	DC: \leq 42 V
Nominal switching current	AC: 5 A
	DC: 2 A
Nominal switching power	1250 VA
Analogue output (optional)	
Type	0... 20 mA or 4...20 mA
Accuracy	+/- 1,0 % of final value
Max. burden	400 Ohms
Temperature coefficient	+/- 0,02 %/K
Sensor supply output	
Voltage	12 V DC
Maximum output current	60 mA

7.2 Operating Conditions

Operating temperature	-25°C...+70°C (LCD-Display -10°...+70°C) -13°C...158°F (LCD-Display+14°...+158°F)
Storage temperature	-25°...+85°C -13...185°F
Relative humidity	Max. 95 % not condensing
Protection (IEC 529)	IP 20
Vibration (IEC 68-2-6)	0,7 g @ 1...100 Hz
Protective class	Protective insulation
EMV Norms	Disturbance resistance: EN 61326-1; EN 61326/A1; EN 61000-4-2; EN 61000-4-3; EN 61000-4-8; EN 61000-4-4; EN 61000-4-5 Germanischer Lloyd 04.2001
	Disturbance sent out: EN 50081-1: 1992; EN 55011 Germanischer Lloyd 04.2001
Additional norms	machine guideline 898/392/EWG; EN 60204-1; safety category 1 according to EN 954-1; EN 50178; low tension guideline 73/23EWG; DIN VDE 0110-1, DIN EN 61010-1; DIN VDE 0106 T1; DIN VDE 0106 T101
Conformity	 Declaration of Conformity available on request
Approvals	 In preparation: DNV, ABS, Class NK, BV, LRS, KRS

7.3 Mechanical Data

Casing type	Normal rail case (for 35 mm mounting rail EN 50 022)
Casing dimensions	43 * 70 * 114 (mm; W*H*D)
Casing material	GFK, polycarbonate (inflammability class UL94-V-0)
Terminals	16 screw clamps with tension contacts
Connection cross section	1 * 2,5 mm ²
	1 * 1,5 mm ² with end sleeve for strands

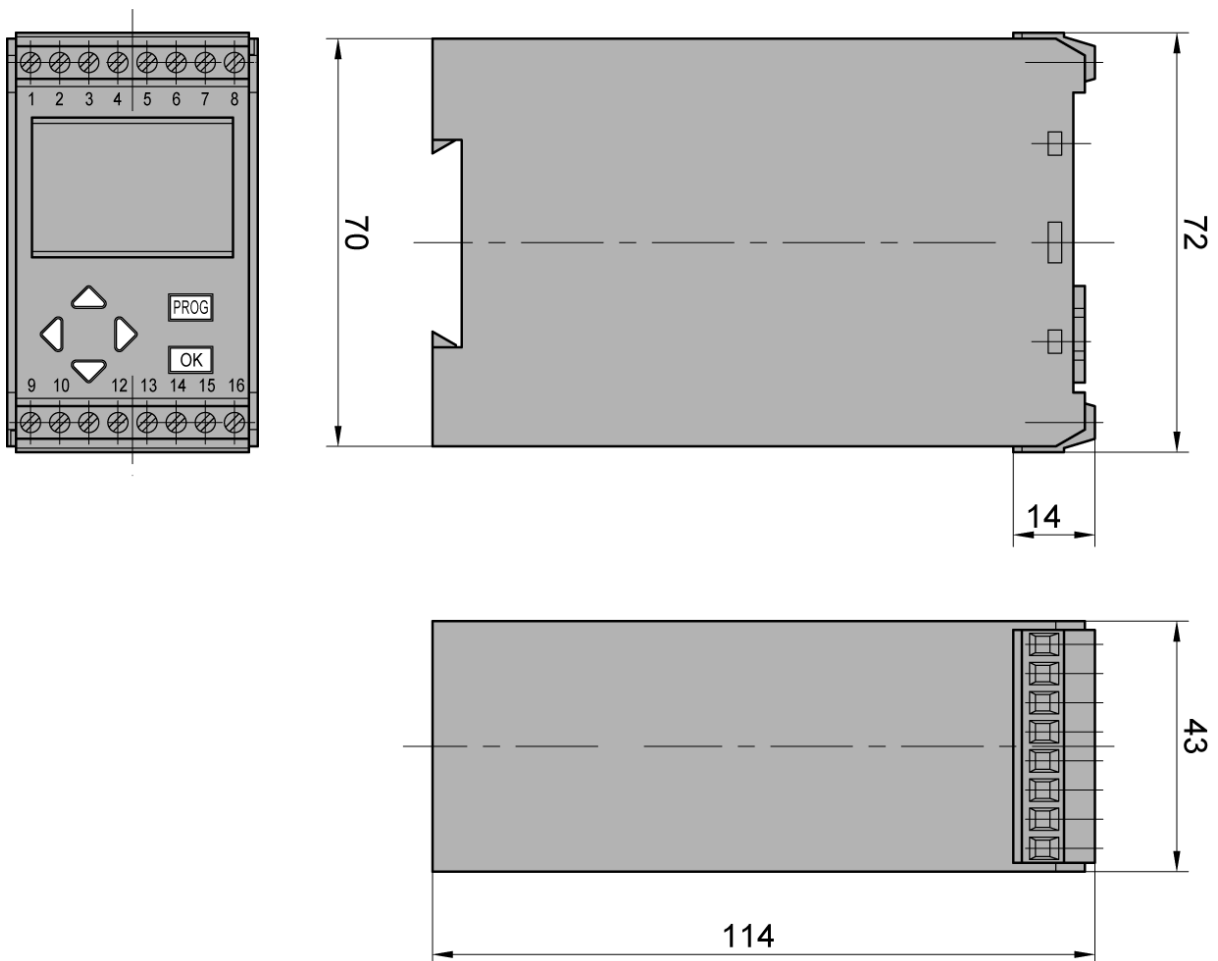

Figure 10 mounting drawing

